

SECTION 501-12: Instrument Panel and Console
REMOVAL AND INSTALLATION

1998 Mark VIII Workshop Manual

Instrument Panel —Center Finish Panel

Removal

1. Disconnect the battery ground cable (14301).

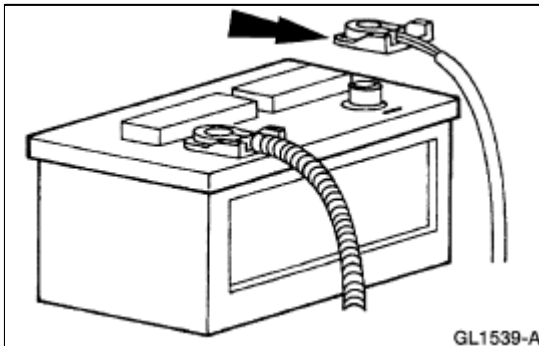

2.  **CAUTION:** Do not pry on the outside edge of the instrument panel control opening cover with a screwdriver or similar tool. Damage to the instrument panel center finish panel may result.

Position the instrument panel control opening cover assembly aside.

1. Pull at each inside corner at the top of the instrument panel control opening cover assembly to release the upper clips.
2. Pull the instrument panel control opening cover assembly straight out to release the lower clip and position aside.

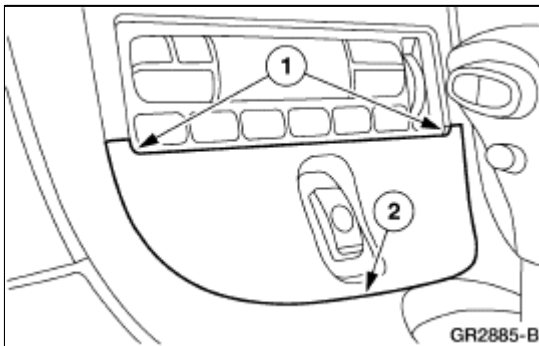

3. Remove the instrument panel control opening cover assembly.
 - Disconnect the electrical connector.
 - If equipped, disconnect the heated seat switch electrical connectors.

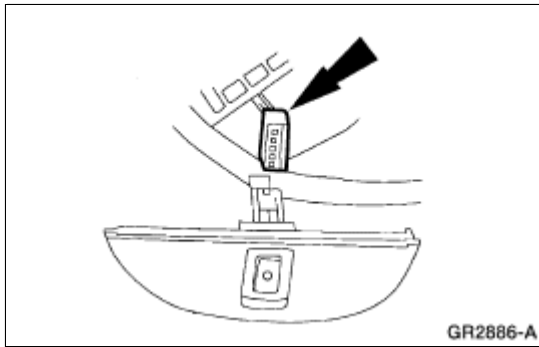

4. Remove the instrument panel center finish panel screws.

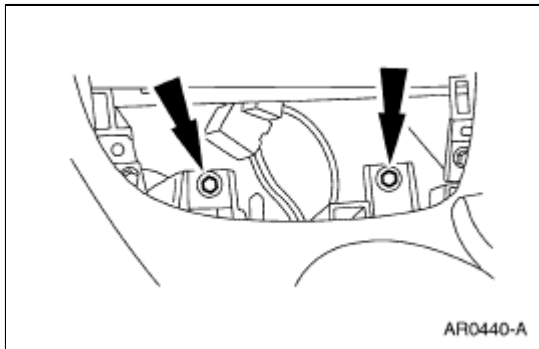

5.  **CAUTION: Do not pry on the outside edges of the instrument panel lower center finish panel.**

Position the instrument panel center finish panel aside.

1. Lift up on the back of the instrument panel center finish panel from inside the opening.
2. Pull the instrument panel center finish panel forward.
3. Position the instrument panel center finish panel aside.

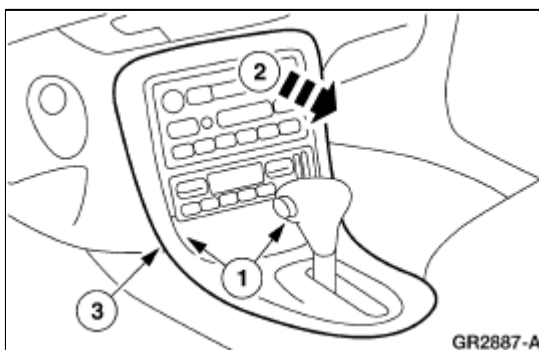

6. Remove the instrument panel center finish panel.
 1. Disconnect the ground wire.
 2. Remove the instrument panel center finish panel.

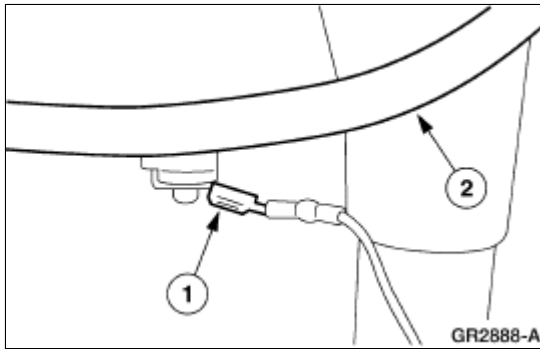

Installation

1. **NOTE:** When the battery (10655) is disconnected and reconnected, some abnormal drive symptoms may occur while the vehicle relearns its adaptive strategy. The vehicle may need to be driven 16 km (10 mi) or more to relearn the strategy.

To install, reverse the removal procedure.

